

20835

PUMPING GLOSSARY

English/French/Spanish

(with definitions and illustrations)

Glossaire des Pompes

Glosario de las Bombas

SECTORAL LIBRARY
INTERNATIONAL BANK
FOR
RECONSTRUCTION AND DEVELOPMENT

Prepared by:
The Terminology Unit
World Bank

FEB 6 1986

TJ
900
.P8
1986

February 1986

FILE COPY

air chamber See illustrations pp 28, 30.	cloche à air; réservoir d'air	cámara de aire
apron A concrete lining or floor to protect the	anti-bourbier; tablier; radier area round a well from erosion.	enlosado; plataforma; piso
bailer	soupape; épuisette	achicador
baldeo balti A type of traditional Indian water pump consisting of two large boat-shaped buckets of iron hinged on a piece of wood placed on the edge of a water tank or channel, which are filled alternately. The system is usually operated by bullocks.	baldeo balti	baldeo balti
ball valve Valve where the opening is closed by a ball made of metal or other material of appropriate specific gravity, usually guided by a ribbed cage.	soupape à boulet	válvula de bola
barrell <u>see</u> pump stand		
bascule A type of traditional pump using a counterpoise lift system.	bascule	báscula
base plate; bottom plate	embase	placa de fondo; placa de base
Battelle pump Dependable hand pump developed by the Battelle Memorial Institute-Columbus Laboratories under contract from the United States Agency for International Development. Shallow and deep well configurations exist.	pompe Battelle	bomba Battelle
bearing A part that supports another part which rotates, slides or oscillates in or on it.	coussinet	cojinete; chamacera
bedrock The solid rock underlying soil or other surface cover.	socle	roca subyacente
block and tackle; block and fall Combination of rope or other flexible material and independently rotating frictionless pulleys.	palan	aparejo de poleas
borehole <u>see</u> drilled well		
bottom plate <u>see</u> base plate		
bucket pump A type of positive displacement hand-operated pump, consisting of small buckets attached to an endless chain which is rotated over sprockets. The term is also sometimes used for a reciprocating well pump whose plunger to cylinder seals are sometimes called "buckets". See illustration p 29.	pompe à godets	noria de cangilones
bucket seal <u>see</u> cup		
bucket valve <u>see</u> plunger valve		
bucket vane	aillette d'aube	paleta

butterfly flapper valve A flapper valve (q.v.) diametrically hinged in two parts across two or more valve openings or concentrically hinged in four parts across four or more valve openings.	soupape à papillon, à clapet	chapaleta mariposa
cage <u>see</u> yoke		
(well) cap; pump cap; (well) cover [dug wells] Component that covers the pump stand and to which the pump handle is attached by a fulcrum. See illustrations pp 30, 31, 32.	calotte de pompe; couverture; plaque-support	cubierta; tapa; casquete; capote
cap ring	bague de calotte	tapa anular
cased well A tubewell (q.v.) lined with casing (q.v.).	puits tubé	pozo entubado
(well) casing; ring Steel tubing welded or screwed together and lowered into a well to prevent entry of loose rock.	tubage (de puits); cuvelage (de puits)	entubado (del pozo)
cavitation Formation of gas- or vapor-filled cavities within liquids by mechanical forces, leading to pounding (q.v.).	cavitation	cavitación
chadouf <u>see</u> shadouf		
chain pump A pump consisting of rubber disks attached to an endless chain running over a sprocket at the top, which are pulled upward through a pipe to lift water mechanically up to the spout. See illustration p 29.	chapelet hydraulique	noria de discos
charsa; churus A type of traditional animal-powered, low-lift irrigation pump, using the principle of the bucket pump (q.v.), though the buckets may be earthenware jars or wooden or metal boxes. Found in India and the Near East.	charsa; churus	charsa; churus
check valve A valve restricting flow to one direction. See illustration p 26.	clapet de retenue	válvula de retención
churus <u>see</u> charsa		
cigoñal A type of traditional pump using a counterpoise lift system.	cigoñal	cigoñal
clack valve <u>see</u> flapper valve		
closed-type cylinder A pump cylinder provided with a cap or top which is threaded to receive the normal drop pipe.	cylindre fermé	cilindro de tipo cerrado
collecting well	puits collecteur	pozo de recolección
column <u>see</u> pump stand		
concrete slab; well cover	dalle en béton; dallage	losa de concreto

connecting rod *see* pump rod

counterweight bailer épuisette à centre poids achicador de contrapeso
A device used to provide a counterbalance weight on a traditional pump.

coupling raccordement; assemblage acoplamiento; acople
Component that connects the pump handle to the pump rod. See illustrations pp 30, 31, 32.

cover *see* cap

crater poche pocillo
Cavity formed on bottom of well in which water collects.

cup; cup seal; bucket seal joint de cuvette; cuvette empaquetadura, empaque de la taza; taza; cubo
Seals placed over the plunger face to prevent backflow between the plunger and cylinder walls during pumping. See illustrations pp 31, 32.

cylinder *see* open-type cylinder; closed-type cylinder

cylinder gasket garniture de cylindre empaquetadura del cilindro

cylinder wall paroi du cylindre pared del cilindro

daly daly daly
A type of traditional animal-powered, low-lift irrigation pump, using the principle of the bucket pump (q.v.), though the buckets may be earthenware jars or wooden or metal boxes. Used in Arab countries.

deep well hand pump pompe à main pour puits profond bomba de mano para pozo profundo
A pump with a long drop pipe and pump rod for operating in deep wells. Well-known examples include the Sholapur, Jalan or Mission pump.

deep well (reciprocating) lift pump pompe élévatoire (à mouvements alternatifs) pour, de puits profonds bomba aspirante (reciproca) para pozo(s) profundo(s)
Similar to shallow well reciprocating lift pump, but with the cylinder submerged in water to prevent priming loss. See illustration p 27.

delou; delu delou; délou; delu delou; delu
A type of traditional animal-powered, low-lift irrigation pump, using the principle of the bucket pump (q.v.), though the buckets may be earthenware jars or wooden or metal boxes. Used in the Arab countries.

dhenkali; dhenkli; dhingli dhenkali; dhenkli; dhingli dhenkali; dhenkli; dhingli
A type of traditional pump using a counterpoise lift system.

diaphragm force pump pompe foulante à diaphragme bomba impelente de diafragma
A type of positive displacement pump which may use a reciprocating handle. As the diaphragm (an elastic membrane) is lifted, liquid is drawn in through the inlet valve; when the diaphragm is depressed, the liquid is forced out. Recent examples include the Vergnet and Petro pumps.

diaphragm pump pompe à membrane, à diaphragme bomba de diafragma
Same as diaphragm force pump (q.v.)

discharge check valve	clapet de retenue pour le refoulement	válvula de retención del émbolo, de descarga
A valve restricting flow to the discharge direction. See illustrations pp 31, 32.		
discharge pipe	see drop pipe	
discharge valve	see plunger valve	
doon	doon	doon
A type of traditional Indian water pump, consisting of a wooden or metal trough oscillating on a fixed center so that one end is alternately depressed into the water and raised above the level of delivery, with the weight of water being equalized by the counterbalance, so that a man who stands over the water on a plank can depress the end of the doon into the stream with his feet and then, by stepping on the plank and lifting slightly with his hands, can slope the trough towards the point of delivery and thus enable the water to run out into the channel.		
double acting pump	pompe à effet double	bomba de doble efecto
A pump which discharges during both directions of piston or plunger travel.		
drawdown	rabattement	descenso de nivel (de agua)
Drop in water level.		
drilled well; borehole; tubewell	forage	pozo perforado
drilling machine; drilling rig	foreuse; atelier de forage	perforadora; equipo de perforación
driven well; shaft well	puits foncé	pozo de hincado
A well constructed by driving a casing, without using any drilling, boring or jetting device.		
drop pipe; riser; riser pipe; rising main; discharge pipe	tuyau de chute; tuyau de montée; colonne ascendante; tuyau de refoulement	tubería de bajada, ascendente, de elevación, de descarga; conducto montante
The pipe which supports the cylinder in the well and also serves as the discharge pipe from the cylinder. See illustrations pp 27, 30, 31, 32.		
dug well	puits creusé	pozo excavado, de brocal
A well constructed by digging with hand tools or digging equipment.		
dynamic suction head loss	perte de charge dynamique	pérdida de carga dinámica
fastener	attache	fijador
faucet	see spout	
flapper valve; clack valve	soupape à clapet; soupape à papillon	chapaleta; válvula de gozne, de charnela
A valve in which a flexible, hinged, horizontal disc, generally made of leather, opens and closes over the valve opening.		
follower	couvercle	contrabrida
foot pump	pompe à pied	bomba de pie
foot valve	see suction valve	

force pump A pump designed to pump water from a source and deliver it to a higher elevation or against pressure. These pumps are enclosed so that the water can be forced to flow against pressure. See illustration p 28.	pompe refoulante	bomba impelente
friction head The head lost due to the effect of frictional forces set up by the moving fluid.	perte de charge due au frottement	carga de fricción
fulcrum The component that attaches the pump handle to the cap. See illustrations pp 30, 31, 32.	pivot	fulcro
gland A movable part in a stuffing box (q.v.) to compress the packing.	gland	collarin
gravel pack A mass of artificially graded coarse material placed round the well screen.	gravier filtre	filtro de grava
guenina A type of traditional pump using a counterpoise lift system.	guenina	guenina
guide bushing	bague de guidage	casquillo de guía
handle See illustrations pp 30, 31, 32.	bras; levier	mango
handle assembly	assemblage du bras	montaje, ensamble del mango
hand pump; human-powered pump A simple water lifting device, powered by human energy and used in rural village drinking water supplies. Note that the first French term is the one recommended for use in the World Bank though the second one may be seen.	pompe à motricité humaine; pompe manuelle	bomba de mano
head	hauteur; charge	altura; carga
helical rotary pump; progressive cavity pump A rotary pump consisting of a single thread helical rotor turning within a double thread helical stator. Often known as "Mono" pump after the English manufacturer of one of the best-known makes. See illustration.	pompe à rotor hélicoïdale	bomba de rotor helicoidal
human-powered pump <i>see</i> hand pump		
hydrant <i>see</i> spout		
hydraulic ram A device for forcing running water to a higher level by using the kinetic energy of flow. The flow of water in the supply pipeline is periodically stopped so that a small portion of water is lifted by the velocity head of a larger portion. See illustration.	bélier hydraulique	ariete hidráulico
immersed pump; submerged, submersible pump A vertical pump submerged in the water.	pompe immergée	bomba sumergida

inlet valve see suction valve

intake screen see screen intake

intake valve see suction valve

jack hammer marteau "hors de trou", perforateur martillo perforador

jantu jantu jantu
A type of traditional Indian water pump.

journal palier muñón de eje
That part of a shaft which is supported by and turns in a bearing. Note that French makes no distinction between inner and outer journal.

journal bearing coussinet de palier cojinete de muñón
A cylindrical bearing which supports a rotating cylindrical shaft.

kerkaz kerkaz kerkaz
A type of traditional pump using a counterpoise lift system.

kheeraz kheeraz kheeraz
A type of traditional pump using a counterpoise lift system.

khetara khetara khetara
A type of traditional pump using a counterpoise lift system.

lat lat lat
A type of traditional pump using a counterpoise lift system.

leather cup seal; leather bucket seal cuir de garniture; joint en cuir (sello de) taza de cuero; (sello de) copa de cuero

lever levier palanca

lift and force pump pompe aspirante et refoulante bomba aspirante-impelente
Hand pump where the water is delivered against a pressure head.

lifting, pumping devices, mechanism moyen d'exhaure, de levage dispositivos, mecanismos para elevar, bombear agua

lift pump see deep well reciprocating lift pump; reciprocating lift pump; shallow well reciprocating lift pump

lined well puits cuvelé pozo revestido
A well protected by an artificial lining.

lining revêtement revestimiento

lip of apron rebord du tablier labio

to lose priming	désamorcer	descebarse
lowlift pump	pompe à charge réduite	bomba de carga baja
mohte; mot; mota	mohte	mohte
A type of traditional Indian animal-powered, low-lift irrigation pump, using the principle of the bucket pump (q.v.), though the buckets may be earthenware jars or wooden or metal boxes.		
Mono pump <u>see</u> helical rotary pump		
mot; mota <u>see</u> mohte		
needle bearing	roulement à aiguille	cojinete de agujas
A roller-type bearing with long rollers of small diameter. The rollers are retained in a flanged cup, have no retainer and bear directly on the shaft.		
New No. 6 pump	Nouvelle pompe No 6	Nueva Bomba No.6
A shallow well hand pump, a cross between a Battelle and the old Maya No. 6 pump, developed by UNICEF with the Bangladesh Department of Public Health Engineering.		
noria	noria	noria
A type of traditional animal-powered, low-lift irrigation pump, using the principle of the bucket pump (q.v.), though the buckets may be earthenware jars or wooden or metal boxes.		
open-type cylinder	cylindre ouvert	cilindro de tipo abierto
A pump cylinder provided with a cap or top that is threaded to receive a drop pipe of large enough diameter to allow the pump rod and plunger assembly to be pulled up the well through the drop pipe.		
outlet <u>see</u> spout		
outlet valve <u>see</u> discharge valve		
paddle wheel	roue à aube	rueda de paleta
A type of traditional water pump.		
parapet; pedestal; plinth [UK]	margelle	brocal
Area built above ground level to prevent surface water from entering the well.		
pendulum pump	pompe à balancier	bomba de péndulo
A new design of pump using the pendulum principle.		
Persian wheel	roue persane	rueda persa
A type of traditional animal-powered, low-lift irrigation pump, using the principle of the bucket pump (q.v.), though the buckets may be earthenware jars or wooden or metal boxes.		
Petro pump <u>see</u> diaphragm force pump		
picottah; picotas	picottah; picotas	picottah; picota
A type of traditional Indian pump using a counterpoise lift system.		

pin; axle Component that holds the coupling to the pump handle. See illustrations pp 30, 31, 32.	axe	pasador
pinned fastener	attache à goupille, à cheville	fijador de, con pasador
pipe bushing	manchon de tuyau	acoplamiento
pipe wrench A tool designed to grip and turn a pipe or rod about its axis in one direction only.	clé à tuyau	llave para tubos
piston <i>see</i> plunger		
piston rod <i>see</i> pump rod		
pit; sump Small depression in which water is collected for pumping.	puisard	cárcamo; cárcavo; zanja
plinth <i>see</i> parapet		
plunger; piston Mechanism which lifts water to pump spout	piston See illustration p 28.	émbolo; pistón
plunger assembly	assemblage du piston	émbolo; pistón
plunger rod <i>see</i> pump rod		
plunger-type pump Same as <u>reciprocating lift pump</u> q.v.	pompe à piston	bomba de émbolo
plunger valve; discharge valve; outlet valve; bucket valve See illustration p 26.	soupape de refoulement; soupape de piston; soupape d'échappement; piston à clapet	válvula del émbolo
poppet valve A cam-operated or spring-loaded mushroom-type valve used for admission and control of fluid. The direction of movement is at right angles to the plane of its seat.	soupape en champignon	válvula de vástago; válvula de leva
positive displacement pump A pump in which a measured quantity of water is entrapped in a space, its pressure is raised and then the water delivered.	pompe à déplacement positif	bomba de desplazamiento positivo
pounding	coups de bélier	golpeteo; zapateo
prime a pump	amorcer une pompe	cebar una bomba
pump body <i>see</i> pump stand		
pump cap <i>see</i> cap		
pump head	tête de pompe	cabeza de la bomba

rotary pump Pump which employs a high speed rotor within a fixed casing.	pompe rotative	bomba rotativa
rotor	rotor	rotor
sakia A type of traditional animal-powered, low-lift irrigation pump, using the principle of the bucket pump (q.v.), though the buckets may be earthenware jars or wooden or metal boxes.	sakia	sakia
sand trap A device for trapping sand or soil particles carried by water.	piège à sable	desarenador
sanitary rope and bucket well A type of pump developed by the World Health Organization, for use with dug wells.	puits d'extraction pour treuil et seau	pozo de garrucha higiénicamente instalado See illustration.
screen <u>see</u> strainer		
screened well; strainer well	puits crépiné	pozo con alcachofa, con criba, con colador
screen intake; intake screen; well screen	crépine de captage, d'admission	criba, colador, alcachofa, rejilla de entrada, de pozo
self-priming	auto-amorçant	autocebante
sealing ring	anneau d'étanchéité	anillo-sello
seamless pipe	tuyau sans joint	tubo sin costura
semi-rotary pump A hand-operated rotary pump which uses a	pompe semi-rotative	bomba semirotativa
	semi-rotary bucket vane. See illustration.	
shadouf; shaduf; shadoof; chadouf A type of traditional Egyptian pump using	shadouf; shaduf; shadoof; chadouf	chaduf
	a counterpoise bailer system. A modified	version was used by the World Health
	Organization in a recent cholera project.	
shaft well <u>see</u> driven well		
shallow well force pump	pompe refoulante pour puits peu profonds	bomba impelente de pozo superficial
shallow well hand pump	pompe à main pour puits peu profonds	bomba de mano para pozo superficial
shallow well (reciprocating) lift pump A type of pump containing a valved plunger	pompe élévatoire (à mouvements alternatifs) pour, de puits peu profonds	bomba aspirante (reciproca) para pozo superficial
	or piston which moves up and down (i.e. reciprocates). See illustration	
shallow well suction pump	pompe aspirante pour puits superficiel	bomba aspirante para pozo superficial
shutoff valve	soupape d'arrêt	válvula de cierre

single acting pump A pump which discharges in only one direction of piston or plunger travel.	pompe à effet simple	bomba de simple efecto
slip Difference between actual rate of discharge and theoretical rate of discharge due to failure of valves to close instantly when the plunger changes direction and to back leakage between the plunger and the cylinder wall during pumping.	écart	pérdida
slotted lining	revêtement lanterné	revestimiento perforado
soakaway	fosse d'infiltration	zanja
spacer	rondelle de réglage	separador
spear valve A winged poppet valve with exaggerated vertical dimensions of the winged stem.	soupape en forme de lance	válvula alanceada
spigot <u>see</u> spout		
spool valve A horizontal disc valve in which the center stem guide is replaced by a concentric vertical wall near the perimeter of the disc.	soupape à bobine	válvula de carrete
spigot; faucet	robinet	espita; grifo
spout; outlet See illustrations pp 30, 31, 32	dégorgeoir de pompe; déversoir; douille; bouche d'eau; bouche de pompe	surtidor; caño; orificio de salida
standard <u>see</u> pump stand		
static head The vertical distance that the water must be raised from its static, at rest, lower level to its ultimate uppermost level at free discharge at the spout or to an elevated tank.	hauteur de charge statique	carga estática
stator	stator	funda
strainer; screen A screen to protect the pump against suspended matter in the water which might cause excessive wear or clogging, placed below the suction check valve.	crépine	criba; colador; rejilla
strainer well <u>see</u> screened well		
stroke (of plunger)	course	carrera
stroke limiter; handle stop	limiteur de course de piston	tope para la brazada
stuffing box A box which acts as a seal to control leakage from the top of the pump stand for force pumps and as a bearing and guide for the pump rod. See illustrations pp 28, 30.	presse-étoupe	caja de estopas
submerged, submersible pump <u>see</u> immersed pump		

sucker pipe; suction (lift) pipe [suction pumps] Any pipe located below the cylinder. See illustration p 26.	tuyau d'aspiration; tuyau ascendant d'aspiration	tubería de succión, de succión-elevación
sucker rod <u>see</u> pump rod		
suction check valve See illustrations pp 31, 32.	clapet de retenue pour l'aspiration	válvula de retención de succión
suction head, lift	hauteur d'aspiration	carga de succión
suction (lift) pipe <u>see</u> sucker pipe		
suction pump	pompe aspirante	bomba aspirante
suction valve; foot valve; intake valve; inlet valve	clapet d'aspiration; soupape d'aspiration; clapet de pied; soupape d'admission	válvula de succión
sump <u>see</u> pit		
swape; sweep A type of traditional pump using a counterpoise bailer system.	swape; sweep	swape; sweep
swept volume	volume balayé	volumen de desplazamiento, de carrera
tank well <u>see</u> reservoir well		
threaded fastener	attache filetée	fijador roscado
trap tube See illustrations pp 28, 30.	collecteur; tuyau-siphon	tubo de trampa de aire
travel (of rods)	mouvement	carrera
trough	abreuvoir	canal
tubewell Strictly speaking a circular well consisting of tubes or pipes bored into the ground but often used synonymously with drilled well (q.v.).	forage; <u>parfois</u> : puits tubulaire	pozo perforado; <u>a veces</u> : pozo tubular; pozo entubado
valve flapper	clapet de soupape	chapaleta
valve opening	ouverture de soupape	abertura de la válvula
valve poppet	clapet de soupape	disco de la válvula
valve seat The perimetric area of the valve opening contacted by the moving flapper, poppet disc or ball.	siège de soupape	asiento de la válvula

Vergnet pump see diaphragm force pump

volumetric efficiency

rendement volumétrique

eficiencia volumétrica

washing nozzle

buse

lanza de lavado

Nozzle at end of jetting pipe through which water shoots and then rises in the space between the casing and jet tube.

washing slab

dalle de lavoir

losa de lavado

water ladder

échelle à eau

escalera hidráulica

A type of traditional water pump.

water seal

joint hydraulique

sello hidráulico

well cap see cap

well casing see casing

well cover see cap; concrete slab

well rod see pump rod

well screen

crépine de puits

rejilla de pozo

windlass pump

pompe à treuil

bomba de manivela

yoke; cage

étrier

yugo; cajuela

A device connecting the pump rod and plunger assembly.

FRENCH-ENGLISH
FRANCAIS-ANGLAIS

abreuvoir	trough
ailette d'aube	bucket vane
amorcer une pompe	prime a pump
anneau d'étanchéité	sealing ring
anti-bourbier	apron
assemblage	coupling
assemblage du bras	handle assembly
assemblage du piston	plunger assembly
atelier de forage	drilling machine; drilling rig
attache	fastener
attache à goupille, à cheville	pinned fastener
attache filetée	threaded fastener
auto-amorçant	self-priming
axe	pin; axle
bague de calotte	cap ring
bague de guidage	guide bushing
baldeo balti	baldeo balti
bascule	bascule
bâti	pump stand; standard; barrell; pump body; column
bélier hydraulique	hydraulic ram
bouche d'eau	pump stand; standard; barrell; pump body; column; spout; outlet
bouche de pompe	spout; outlet
bras	handle
buse	washing nozzle
calotte de pompe	(well) cap; pump cap; (well) cover
cavitation	cavitation
chadouf	shadouf; shaduf; shadoof; chadouf
chapelet hydraulique	chain pump
charge	head
charsa	charsa; churus
cheville <u>see</u> attache à cheville	
churus	charsa; churus
cigoñal	cigoñal
clapet d'aspiration	suction valve; foot valve; intake valve; inlet valve
clapet de pied	suction valve; foot valve; intake valve; inlet valve
clapet de retenue	check valve
clapet de retenue pour l'aspiration	suction check valve
clapet de retenue pour le refoulement	discharge check valve
clapet de soupape	valve flapper; valve poppet
clé à tuyau	pipe wrench
cloche à air	air chamber
collecteur	trap tube
colonne	pump stand; standard; barrell; pump body; column
colonne ascendante	drop pipe; riser; riser pipe; rising main; discharge pipe
corps de pompe	pump stand; standard; barrell; pump body; column
coups de bélier	pounding
course	stroke (of plunger)
coussinet	bearing
coussinet de palier	journal bearing
couvercle	follower
couverture	(well) cap; pump cap; (well) cover

crépine	strainer; screen
crépine de captage, d'admission	screen intake; intake screen; well screen
crépine de puits	well screen
cric	pump jack
cuir de garniture	leather cup seal; leather bucket seal
cuir de pompe	pump leather
cuvelage (de puits)	(well) casing; ring
cuvette	cup; cup seal; bucket seal
cylindre	pump stand; standard; barrell; pump body; column
cylindre fermé	closed-type cylinder
cylindre ouvert	open-type cylinder
dallage	concrete slab; well cover
dalle de lavoir	washing slab
dalle en béton	concrete slab; well cover
daly	daly
débit de refoulement	rate of discharge
dégorgoir de pompe	spout; outlet
delou	delou; delu
délou	delou; delu
delu	delou; delu
désamorcer	to lose priming
déversoir	spout; outlet
dhenkali	dhenkali; dhenkli; dhingli
dhenkli	dhenkali; dhenkli; dhingli
dhingli	dhenkali; dhenkli; dhingli
doon	doon
douille	spout; outlet
écart	slip
échelle à eau	water ladder
embase	base plate; bottom plate
épuiette	bailer
épuiette à centre poids	counterweight bailer
étrier	yoke; cage
fonçage rotary	rotary drilling
forage	drilled well; borehole; tubewell
foreuse	drilling machine; drilling rig
fosse d'infiltration	soakaway
garniture de cylindre	cylinder gasket
gland	gland
goupille <u>see</u> attache à goupille	
gravier filtre	gravel pack
guenina	head
hauteur	head
hauteur d'aspiration	suction head, lift
hauteur de charge statique	static head
jantu	jantu
joint de cuvette	cup; cup seal; bucket seal
joint en cuir	leather cup seal; leather bucket seal
joint hydraulique	water seal
kerkaz	kerkaz

kheeraz	kheeraz
khetara	khetara
lat	lat
levier	handle; lever
limiteur de course de piston	stroke limiter; handle stop
manchon de tuyau	pipe bushing
margelle	parapet; pedestal; plinth
marteau "hors de trou", perforateur	jack hammer
mohte	mohte; mot; mota
montant	pump stand; standard; barrell; pump body; column
mouvement	travel (of rods)
moyen d'exhaure, de levage	lifting, pumping devices, mechanism
noria	noria
Nouvelle pompe No.6	New No. 6 pump
ouverture de soupape	valve opening
palan	block and tackle; block and fall
palier	journal
paroi du cylindre	cylinder wall
perte de charge dynamique	dynamic suction head loss
perte de charge due au frottement	friction head
picotas	picottah; picotas
picottah	picottah; picotas
piège à sable	sand trap
piston	plunger; piston
piston à clapet	plunger valve; discharge valve; outlet valve; bucket valve
pivot	fulcrum
plaque-support	(well) cap; pump cap; (well) cover
poche	crater
pompe à balancier	pendulum pump
pompe à charge réduite	lowlift pump
pompe à corde	rope pump
pompe à déplacement positif	positive displacement pump
pompe à effet double	double acting pump
pompe à effet simple	single acting pump
pompe à godets	bucket pump
pompe à main à mouvements alternatifs	reciprocating hand pump
pompe à main pour puits profond	deep well hand pump
pompe à main pour puits peu profonds	shallow well hand pump
pompe à membrane, à diaphragme	diaphragm pump
pompe à motricité humaine	hand pump; human-powered pump
pompe à mouvements alternatifs	reciprocating lift pump
pompe à pied	foot pump
pompe à piston	plunger-type pump
pompe à rotor hélicoïdale	helical rotary pump; progressive cavity pump
pompe à treuil	windlass pump
pompe à tringle	reciprocating lift pump
pompe alternative à piston	reciprocating plunger pump
pompe aspirante	suction pump
pompe aspirante et refoulante	lift and force pump

pompe aspirante pour puits superficiel	shallow well suction pump
pompe Battelle	Battelle pump
pompe élévatoire à mouvements alternatifs pour, de puits profonds	deep well reciprocating lift pump
pompe élévatoire à mouvements alternatifs pour, de puits peu profonds	shallow well reciprocating lift pump
pompe foulante à diaphragme	diaphragm force pump
pompe foulante à mouvements alternatifs	reciprocating force pump
pompe immergée	immersed pump; submerged, submersible pump
pompe manuelle	hand pump; human-powered pump
<i>pompe refoulante</i>	force pump
pompe refoulante pour puits peu profonds	shallow well force pump
pompe rotative	rotary pump
pompe semi-rotative	semi-rotary pump
presse-étoupe	stuffing box
puisard	pit; sump
puits citernes	reservoir well; tank well
puits collecteur	collecting well
puits crépiné	screened well; strainer well
puits creusé	dug well
puits cuvelé	lined well
puits d'extraction pour treuil et seau	sanitary rope and bucket well
puits foncé	driven well; shaft well
puits tubé	cased well
puits tubulaire	tubewell
pur	pur
rabattement	drawdown
raccordement	coupling
radier	apron
ramioko	ramioko
rebord du tablier	lip of apron
rendement volumétrique	volumetric efficiency
réservoir d'air	air chamber
revêtement	lining
revêtement lanterne	slotted lining
robinet	spigot; faucet
rondelle de réglage	spacer
rotor	rotor
roue à aube	paddle wheel
roue persane	Persian wheel
roulement à aiguille	needle bearing
sakia	sakia
shadoof	shadoof; shaduf; shadoof; chadouf
<i>shadouf</i>	shadouf; shaduf; shadoof; chadouf
shaduf	shadouf; shaduf; shadoof; chadouf
siège de soupape	valve seat
socle	bedrock
soupape	bailer
soupape à bobine	spool valve
soupape à boulet	ball valve
soupape à clapet	flapper valve; clack valve; butterfly flapper valve

soupape à papillon	flapper valve; clack valve; butterfly flapper valve
soupape d'admission	suction valve; foot valve; intake valve; inlet valve
soupape d'arrêt	shutoff valve
soupape d'aspiration	suction valve; foot valve; intake valve; inlet valve
soupape d'échappement	plunger valve; discharge valve; outlet valve; bucket valve
soupape de piston	plunger valve; discharge valve; outlet valve; bucket valve
soupape de refoulement	plunger valve; discharge valve; outlet valve; bucket valve
soupape en champignon	poppet valve
soupape en forme de lance	spear valve
stator	stator
support de pompe	pump stand; standard; barrell; pump body; column
swape	swape; sweep
sweep	swape; sweep
tablier	apron
tête de pompe	pump head
tige de piston	pump rod; plunger rod; piston rod; sucker rod; well rod
tige de plongeur	pump rod; plunger rod; piston rod; sucker rod; well rod
tige de pompe	pump rod; plunger rod; piston rod; sucker rod; well rod
tige de pompe aspirante	pump rod; plunger rod; piston rod; sucker rod; well rod
tige de puits	pump rod; plunger rod; piston rod; sucker rod; well rod
tringle	pump rod; plunger rod; piston rod; sucker rod; well rod
tringle de liaison	pump rod; plunger rod; piston rod; sucker rod; well rod
tubage (de puits)	(well) casing; ring
tuyau ascendant d'aspiration	sucker pipe; suction (lift) pipe
tuyau d'aspiration	sucker pipe; suction (lift) pipe
tuyau de chute	drop pipe; riser; riser pipe; rising main; discharge pipe
tuyau de montée	drop pipe; riser; riser pipe; rising main; discharge pipe
tuyau de refoulement	drop pipe; riser; riser pipe; rising main; discharge pipe
tuyau sans joint	seamless pipe
tuyau-siphon	trap tube
volume balayé	swept volume

SPANISH-ENGLISH
ESPAÑOL-INGLES

abertura de la válvula	valve opening
achicador	bailer
achicador de contrapeso	counterweight bailer
acoplamiento	coupling; pipe bushing
acople	coupling
alcachofa de entrada, de pozo	screen intake; intake screen; well screen
altura	head
anillo-sello	sealing ring
aparejo de poleas	block and tackle; block and fall
ariete hidráulico	hydraulic ram
asiento de la válvula	valve seat
autocebante	self-priming
baldeo balti	baldeo balti
baril	pump stand; standard; barrell; pump body; column
báscula	bascule
bomba aspirante	suction pump
bomba aspirante-impelente	lift and force pump
bomba aspirante para pozo superficial	shallow well suction pump
bomba aspirante reciproca	reciprocating lift pump
bomba aspirante reciproca para pozo(s) profundo(s)	deep well reciprocating lift pump
bomba aspirante reciproca para pozo superficial	shallow well reciprocating lift pump
bomba Battelle	Battelle pump
bomba de carga baja	lowlift pump
bomba de desplazamiento positivo	positive displacement pump
bomba de diafragma	diaphragm pump
bomba de doble efecto	double acting pump
bomba de émbolo	plunger-type pump
bomba de émbolo de acción reciproca	reciprocating plunger pump
bomba de manivela	windlass pump
bomba de mano	hand pump; human-powered pump
bomba de mano para pozo profundo	deep well hand pump
bomba de mano para pozo superficial	shallow well hand pump
bomba de mano reciproca	reciprocating hand pump
bomba de péndulo	pendulum pump
bomba de pie	foot pump
bomba de rotor helicoidal	helical rotary pump; progressive cavity pump
bomba de simple efecto	single acting pump
bomba impelente	force pump
bomba impelente de diafragma	diaphragm force pump
bomba impelente de pozo superficial	shallow well force pump
bomba impelente reciproca	reciprocating force pump
bomba rotativa	rotary pump
bomba semirotativa	semi-rotary pump
bomba sumergida	immersed pump; submerged, submersible pump
brocal	parapet; pedestal; plinth
cabeza de la bomba	pump head
caja de estopas	stuffing box
cajuela	yoke; cage

cámara de aire	air chamber
canal	trough
caño	spout; outlet
capote	(well) cap; pump cap; (well) cover
cárcamo	pit; sump
cárcavo	pit; sump
carga	head
carga de fricción	friction head
carga de succión	suction head, lift
carga estática	static head
carrera	stroke (of plunger); travel (of rods)
casquete	(well) cap; pump cap; (well) cover
casquillo de guía	guide bushing
caudal de descarga	rate of discharge
cavitación	cavitation
cebar una bomba	prime a pump
cigoñal	cigoñal
cilindro de tipo abierto	open-type cylinder
cilindro de tipo cerrado	closed-type cylinder
cojinete	bearing
cojinete de agujas	needle bearing
cojinete de muñón	journal bearing
colador	strainer; screen
colador de entrada, de pozo	screen intake; intake screen; well screen
collarín	gland
conducto montante	drop pipe; riser; riser pipe; rising main; discharge pipe
contrabrida	follower
copa de cuero	leather cup seal; leather bucket seal
criba	strainer; screen
criba de entrada, de pozo	screen intake; intake screen; well screen
cubierta	(well) cap; pump cap; (well) cover
cubo	cup; cup seal; bucket seal
cuerpo de bomba	pump stand; standard; barrell; pump body; column
chaduf	shadouf; shaduf; shadoof; chadouf
chamacera	bearing
chapaleta	flapper valve; clack valve; valve flapper
chapaleta mariposa	butterfly flapper valve
charsa	charsa; churus
churus	charsa; churus
daly	daly
delou	delou; delu
delu	delou; delu
desarenador	sand trap
descebarse	to lose priming
descenso de nivel (de agua)	drawdown
dhenkali	dhenkali; dhenkli; dhingli
dhenkli	dhenkali; dhenkli; dhingli
dhingli	dhenkali; dhenkli; dhingli
disco de la válvula	valve poppet
dispositivos para elevar, bombear agua	lifting, pumping devices, mechanism

doon
eficiencia volumétrica
émbolo
empaque de la taza
empaquetadura de la taza
empaquetadura del cilindro
entosado
entubado (del pozo)
equipo de perforación
escalera hidráulica
espita
estándar
fijador
fijador de, con pasador
fijador roscado
filtro de grava
fulcro
funda
golpeteo
grifo
guenina
guimbaleta
jantu
kerkaz
kheeraz
khetara
labio
lanza de lavado
lat
losa de concreto
losa de lavado
llave para tubos
mango
martillo perforador
mecanismos para elevar, bombear agua
mohte
montaje, ensamble del mango
muñón de eje
noria
noria de cangilones
noria de cordel
noria de discos
Nueva Bomba No.6
orificio de salida
palanca
paleta
pared del cilindro
pasador
pérdida
pérdida de carga dinámica

doon
volumetric efficiency
plunger; piston; plunger assembly
cup; cup seal; bucket seal
cup; cup seal; bucket seal
cylinder gasket
apron
(well) casing; ring
drilling machine; drilling rig
water ladder
spigot; faucet
pump stand; standard; barrell; pump body; column
fastener
pinned fastener
threaded fastener
gravel pack
fulcrum
stator
pounding
spigot; faucet
guenina
pump jack
jantu
kerkaz
kheeraz
khetara
lip of apron
washing nozzle
lat
concrete slab; well cover
washing slab
pipe wrench
handle
jack hammer
lifting, pumping devices, mechanism
mohte; mot; mota
handle assembly
journal
noria
bucket pump
rope pump
chain pump
New No. 6 pump
spout; outlet
lever
bucket vane
cylinder wall
pin; axle
slip
dynamic suction head loss

perforación rotativa	rotary drilling
perforadora	drilling machine; drilling rig
picota	picottah; picotas
picottah	picottah; picotas
piso	apron
pistón	plunger; piston; plunger assembly
placa de base	base plate; bottom plate
placa de fondo	base plate; bottom plate
plataforma	apron
pocillo	crater
pozo con alcachofa, con criba, con colador	screened well; strainer well
pozo de depósito	reservoir well; tank well
pozo de embalse	reservoir well; tank well
pozo de garrucha higiénicamente instalado	sanitary rope and bucket well
pozo de hincado	driven well; shaft well
pozo de recolección	collecting well
pozo entubado	cased well; tubewell
pozo excavado, de brocal	dug well
pozo perforado	drilled well; borehole; tubewell
pozo revestido	lined well
pozo tubular	tubewell
pur	pur
ramioko	ramioko
rejilla	strainer; screen
rejilla de entrada, de pozo	screen intake; intake screen; well screen
revestimiento	lining
revestimiento perforado	slotted lining
roca subyacente	bedrock
rotor	rotor
rueda de paleta	paddle wheel
rueda persa	Persian wheel
sakia	sakia
(sello de) copa de cuero	leather cup seal; leather bucket seal
(sello de) taza de cuero	leather cup seal; leather bucket seal
sello hidráulico	water seal
separador	spacer
soporte de la bomba	pump stand; standard; barrell; pump body; column
surtidor	spout; outlet
swape	swape; sweep
Sweep	swape; sweep
tapa	(well) cap; pump cap; (well) cover
tapa anular	cap ring
taza	cup; cup seal; bucket seal
taza de cuero	leather cup seal; leather bucket seal
tope para la brazada	stroke limiter; handle stop
tubería de bajada, ascendente, de elevación, de descarga	drop pipe; riser; riser pipe; rising main; discharge pipe
tubería de succión, de succión-elevación	sucker pipe; suction (lift) pipe
tubo de trampa de aire	trap tube
tubo sin costura	seamless pipe

válvula alanceada	spear valve
válvula de bola	ball valve
válvula de carrete	spool valve
válvula de cierre	shutoff valve
válvula de charnela	flapper valve; clack valve
válvula de gozne	flapper valve; clack valve
válvula del émbolo	plunger valve; discharge valve; outlet valve; bucket valve
válvula de leva	poppet valve
válvula de retención	check valve
válvula de retención de descarga	discharge check valve
válvula de retención del émbolo	discharge check valve
válvula de retención de succión	suction check valve
válvula de succión	suction valve; foot valve; intake valve; inlet valve
válvula de vástago	poppet valve
varilla de la bomba, del émbolo, del pistón	pump rod; plunger rod; piston rod; sucker rod; well rod
volumen de desplazamiento, de carrera	swept volume
yugo	yoke; cage
zanja	pit; sump; soakaway
zapateo	pounding
zapatilla	pump leather

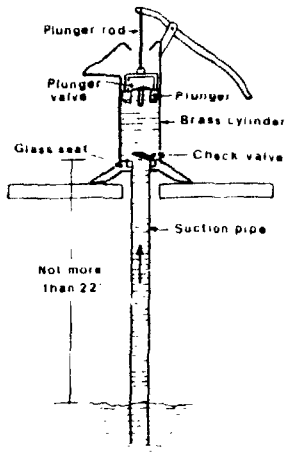
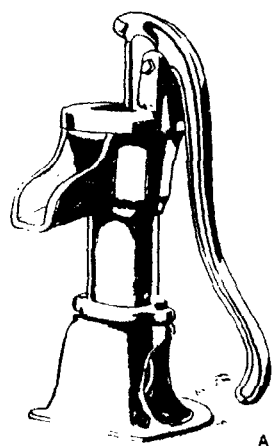

TYPICAL SHALLOW WELL LIFT PUMP

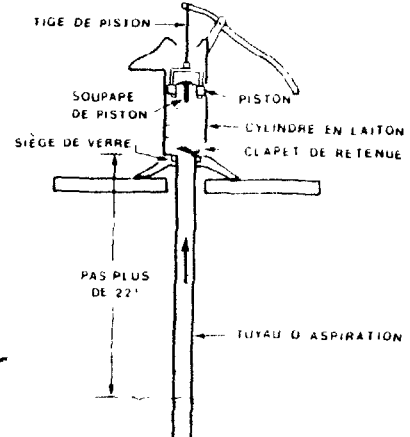
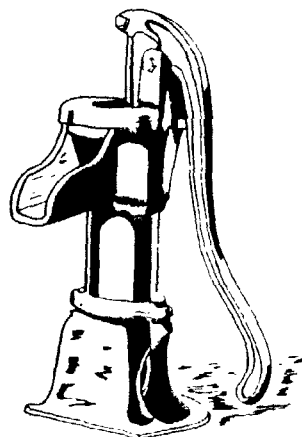

POMPE ELEVATOIRE DE PUIS PEU PROFOND

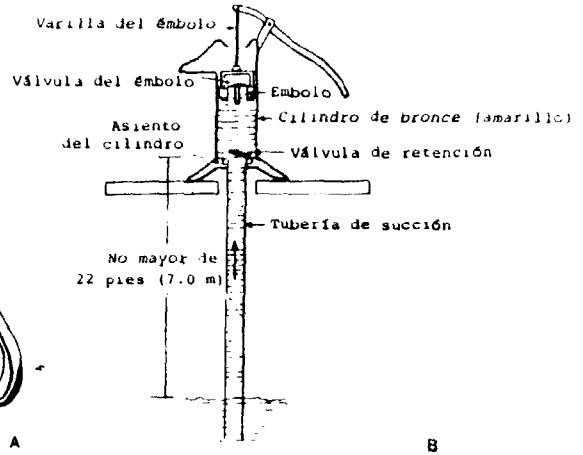
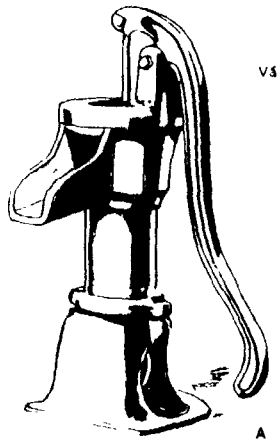

TIPICA BOMBA ASPIRANTE PARA POZO SUPERFICIAL

POMPE ELEVATOIRE DE PUIS PROFOND

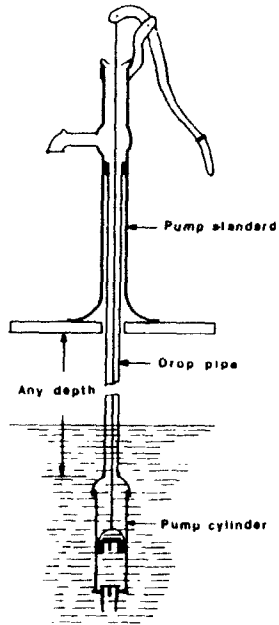

DEEP WELL LIFT PUMP

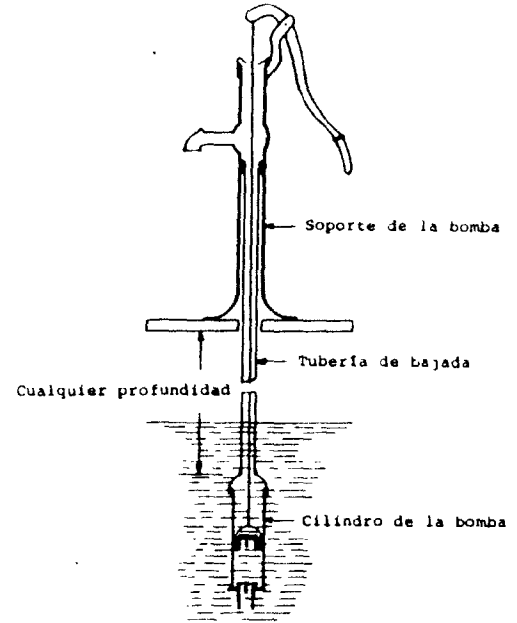
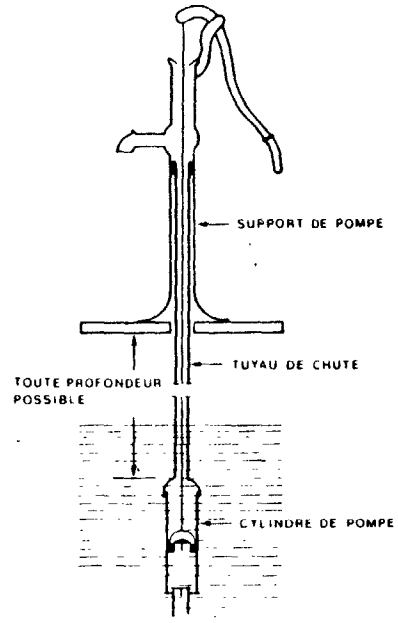

BOMBA ASPIRANTE PARA POZO PROFUNDO

POMPES FOUCANTES

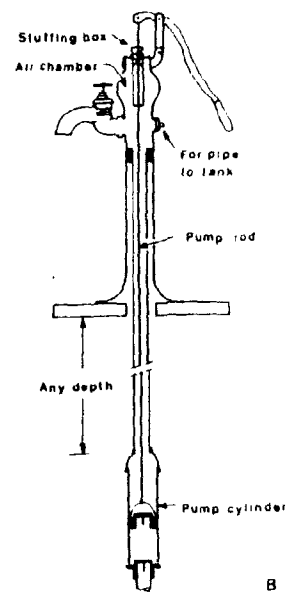
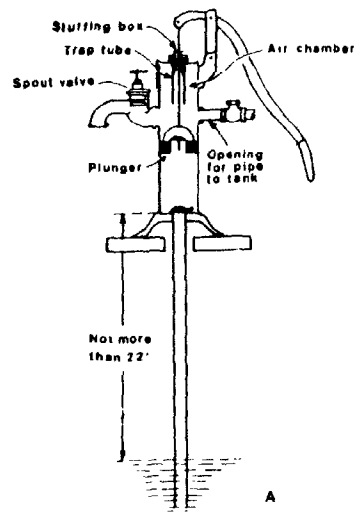

FORCE PUMPS

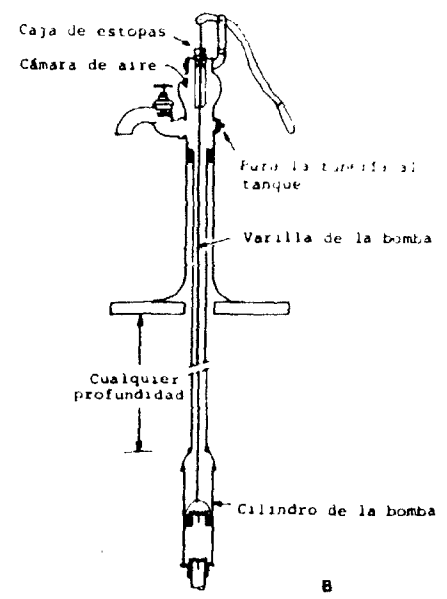
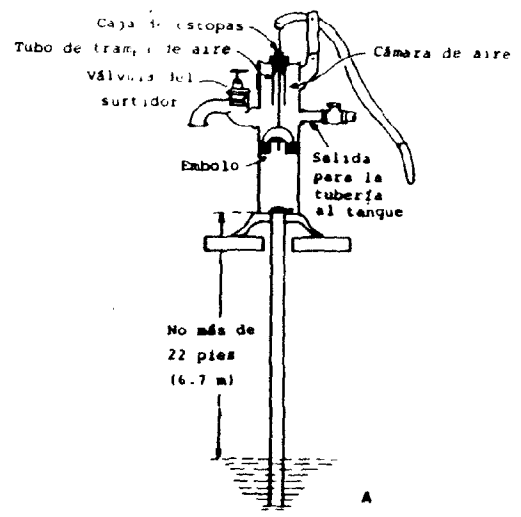
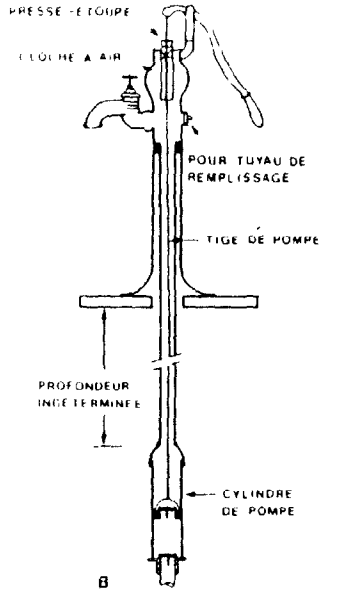
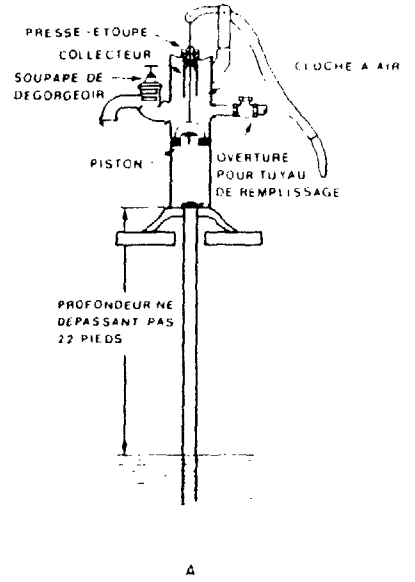

BOMBAS IMPELENTES

POMPE A GODETS

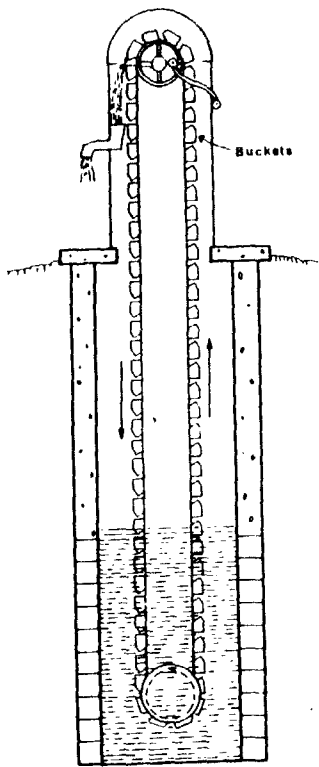

BUCKET PUMP

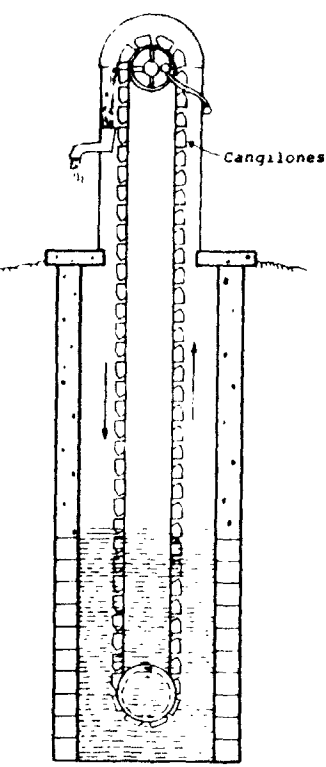
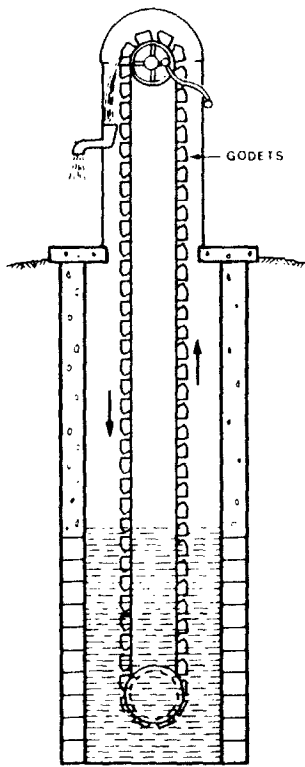

NORIA DE CANGILONES

CHAPELLE HYDRAULIQUE

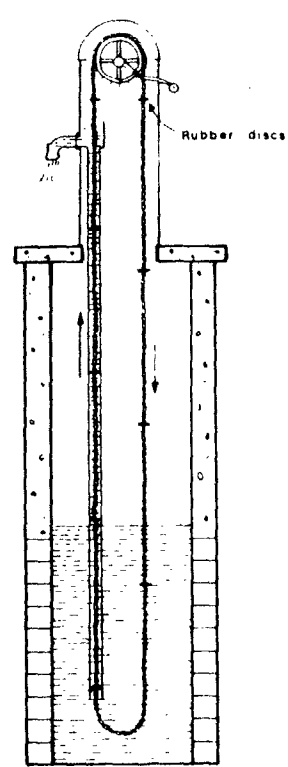

CHAIN PUMP

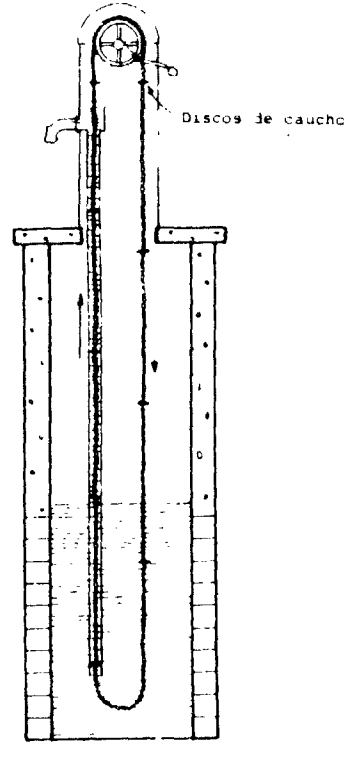
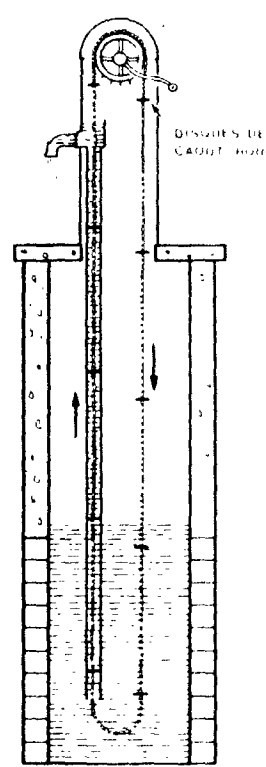

NORIA DE DISCOS

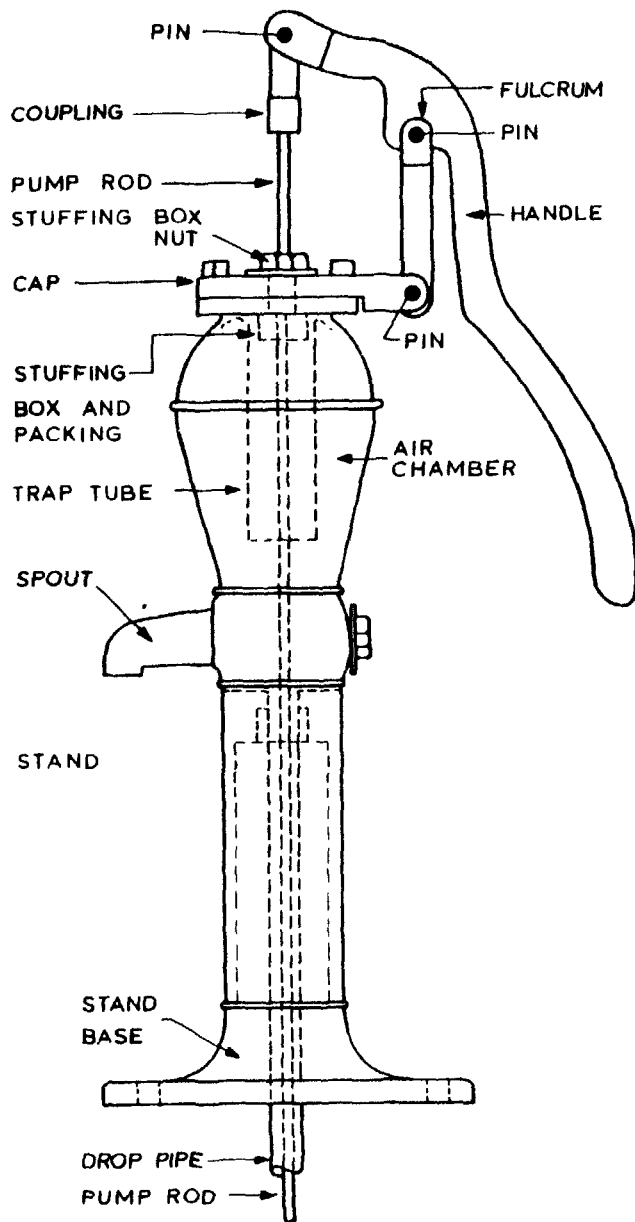

HAND PUMP WITH STUFFING BOX AND GUIDED PUMP ROD
SUITABLE FOR USE AS A FORCE PUMP

POMPE A MAIN MUNIE D'UN PRESSE-ETOUPE ET D'UNE TIGE DE
POMPE GUIDEE POUVANT ETRE UTILISEE COMME POMPE IMPE-
LANTE

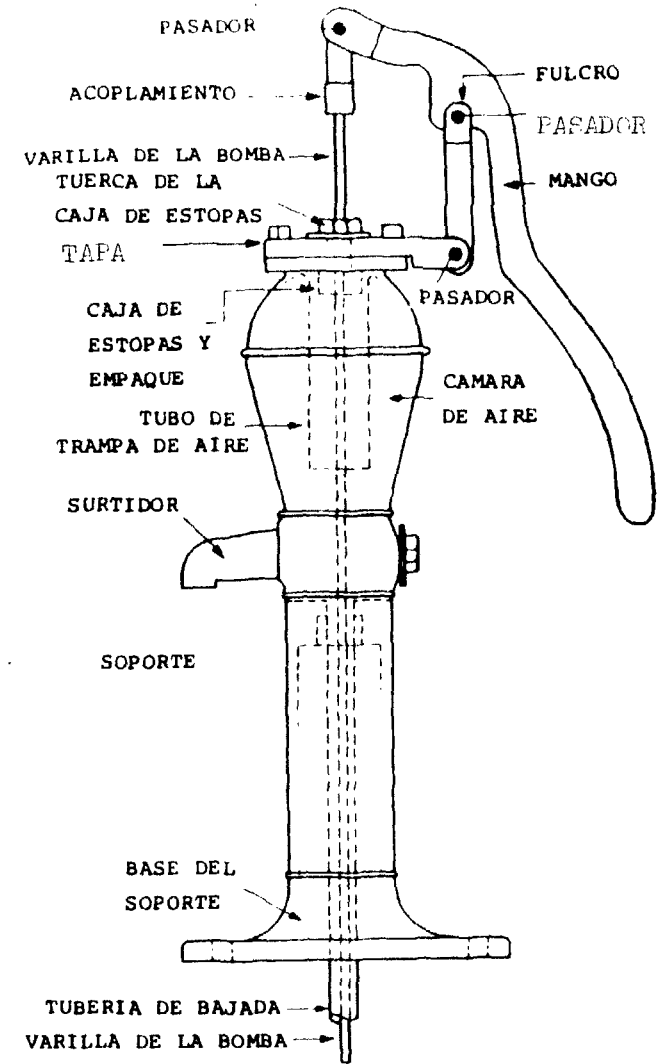
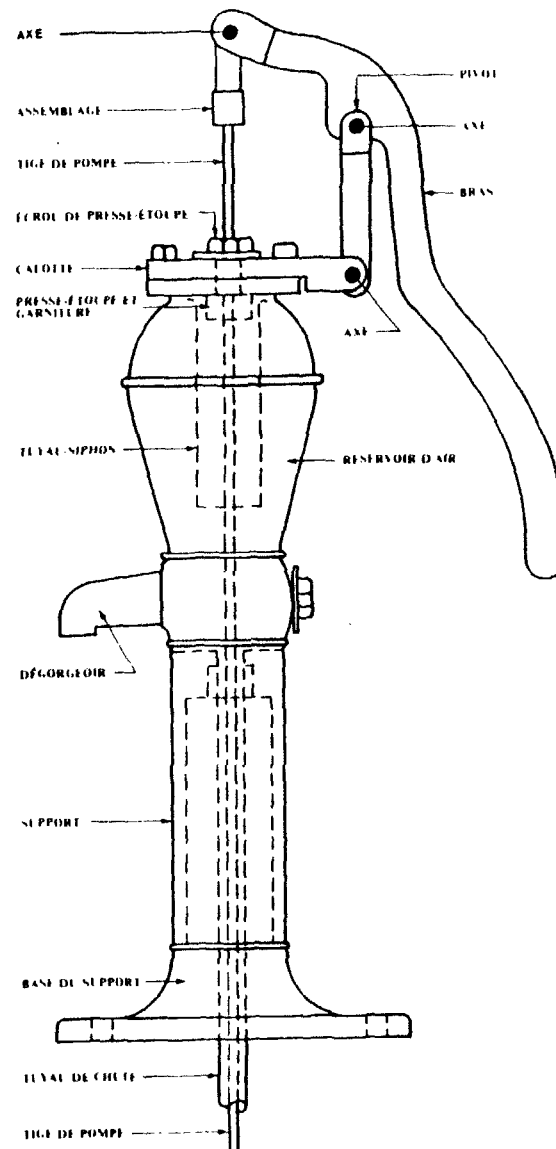

BOMBA DE MANO CON CAJA DE ESTOPAS Y VARILLA
GUIADA QUE PUEDE USARSE COMO BOMBA IMPELENTE

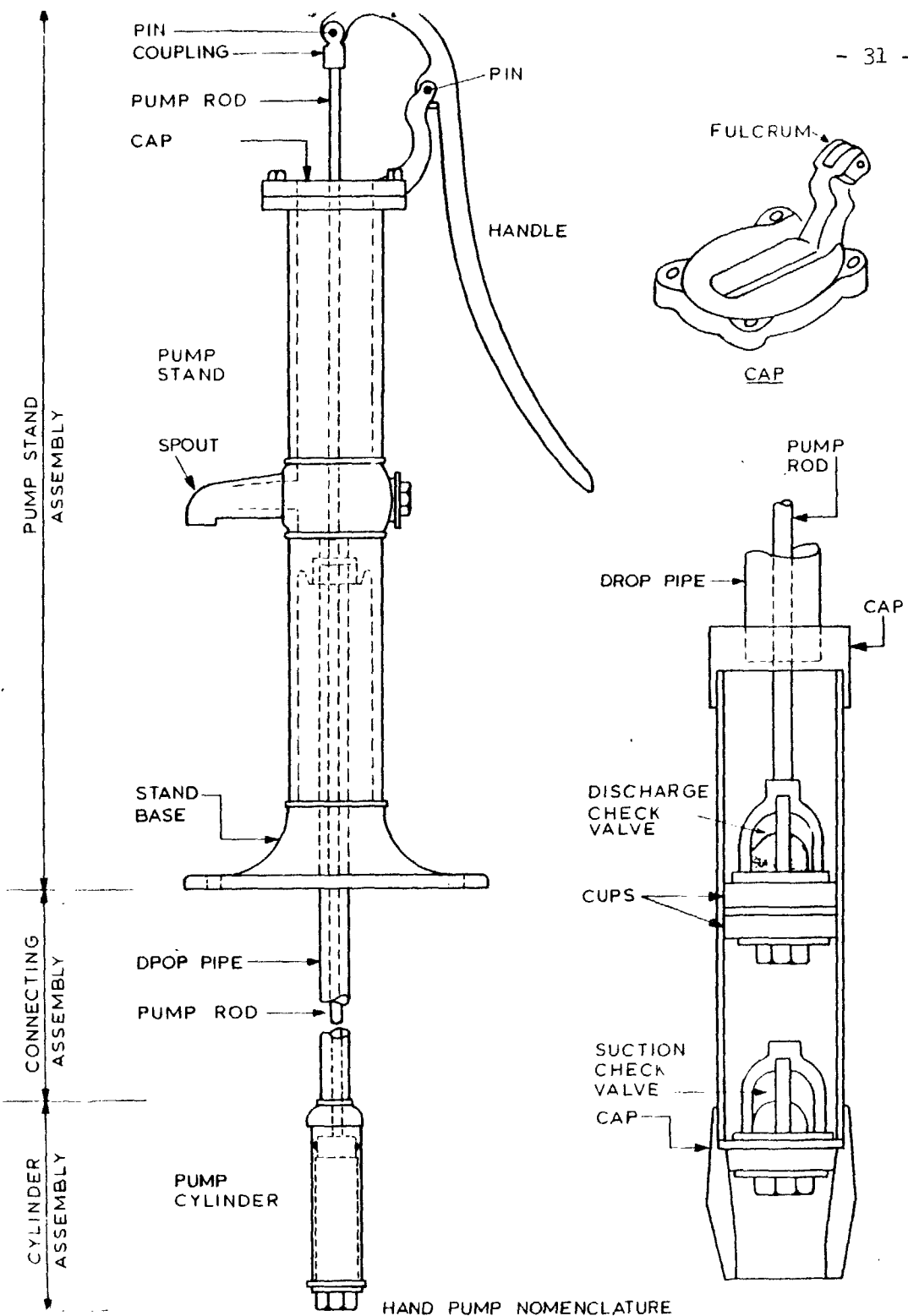

NOMENCLATURE DE LA POMPE A MAIN

